

Surface mounting – Use the two holes marked 'A' in Fig 2. Cable entry is through the most appropriate cut out.

Remove the appropriate cable entry cut outs before fixing the box, where possible drill the box to provide a close fitting entry for cables, taking care to remove sharp edges.

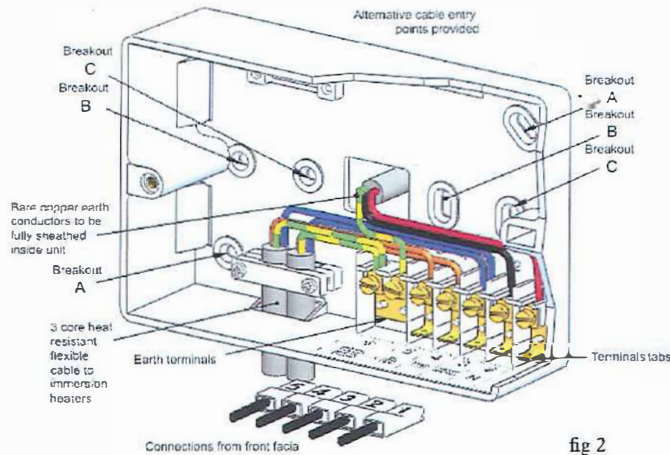

Ensure terminal screws including earth are securely tightened to a minimum torque of 0.75N

Ensure outgoing cables to the immersion heaters are securely clamped in the box. All surface wiring adjacent to the box should also be clamped appropriately or trunking used.

**Commissioning**

When the product leaves the factory, the Installer Switch (fig 4) is already set at program 0. The product settings may be reviewed/entered when not connected to a power supply. Pressing '-' or '+' button will activate the display and enable the review/settings to be made. (NB:- to conserve battery power, the display will die after approx 45 sec. when off power) See user instructions section for operating details.

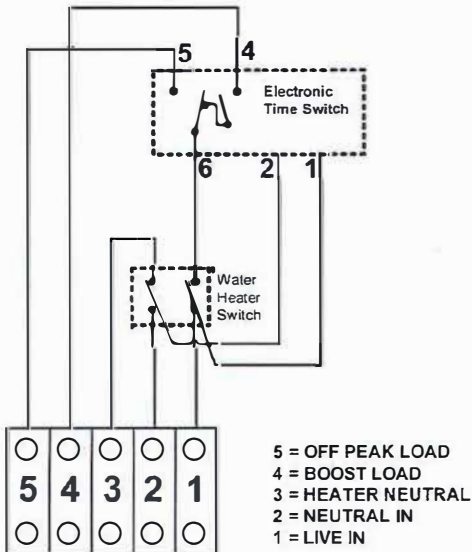

fig 2

fig 4

**Connections** (as labelled)

Use a three core heat resistant cable with minimum conductor size of 1.5mm connection to a 3kW heater. Connect the incoming wires to terminal block as follows



You need to check with your Electricity Supplier to confirm the Off Peak Electricity times used in your area and whether these times change during Winter and Summer.

**It is the responsibility of the installer to ensure that the correct setting is applied for the appropriate electricity tariff.**

Use the slotted screwdriver supplied to set the installer switch to the required program times.

See table on back page.

fig 3

**NB:** A program can comprise 1, 2 or 3 on/off's programs depending on the one selected. Some program times remain same from Winter to Summer. Some program times change with Winter and Summer. For greater flexibility, program times are adjustable within the preset limits. The clock time displayed will automatically adjust no matter which program selected.

To complete installation, take front panel and push connectors numbered 1-5 into the corresponding terminal in mounting base as per fig 2. Carefully secure the front panel to the mounting box and secure with fixing screws. Ensure no wiring becomes trapped or damaged in the process.

Switch on the mains supply and put the rocker switch in the TIMED position.

**User Instructions**

**Backlit Display**

**On/Off Switch**

**On/Off Switch**

In the OFF position, the electrical supply to the water tank immersion heaters is disconnected even though the display continues to operate normally. In the TIMED position, all programs and functions are active.

**Backlit Display**

The display is permanently backlit when mains power is applied. This is useful where a product is installed in cupboards or dark environments. (NB: to conserve battery power, this feature is disabled when unit is not connected to a power supply).

**Output Indicators**

The indicators confirm the status of the Powersaver Dual's switching relays for each immersion element.

**Boost Button** - This boost button is used where on a random basis more hot water is required outwith any off peak program times.

- Press 1 x = 30mins
- Press 2 x = 1 hour
- Press 3 x = 2 hour
- Press 4 x = Cancel

The display changes to show the time remaining in the Boost period.

**Boost Program** - Boost program times must be set outwith any off peak program times to a maximum duration of 2 hours.

Press Boost button x 1 = cancel.

N.B. Off peak programs always take priority over Boost functions.

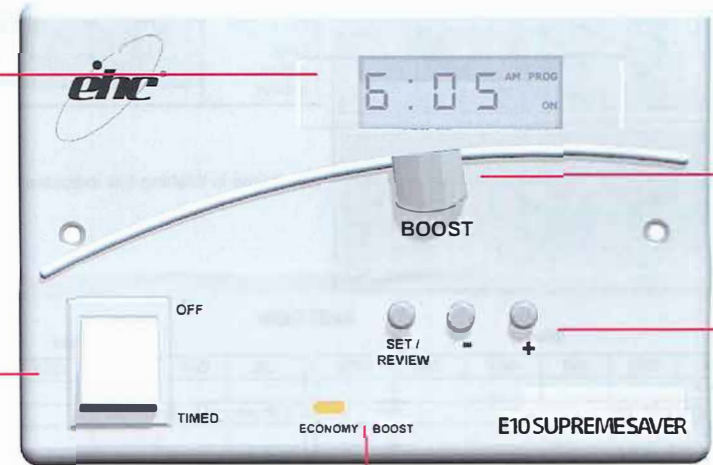

**Output Indicators**

**Set/Review Button**

Press 1 x	Time flashing ; Set time; Press – or + to adjust time
Press 2 x	Off peak 1st on time flashing; Press – or + to adjust time
Press 3 x	Off peak 1st off time flashing; Press – or + to adjust time; If no more programmes, skip to press 8
Press 4 x	Off peak 2nd on time flashing; Press – or + to adjust time
Press 5 x	Off peak 2nd off time flashing; Press – or + to adjust time If no more programmes, skip to press 8
Press 6 x	Off peak 3rd on time flashing; Press – or + to adjust time
Press 7 x	Off peak 3rd off time; flashing; Press – or + to adjust time
Press 8 x	Boost Program on time flashing; Press – or + to adjust time
Press 9 x	Boost Program off time flashing; Press – or + to adjust time; max 2hours
Press 10 x	Return to normal display

Link terminals 4 & 5 when using a single immersion heater

Normal

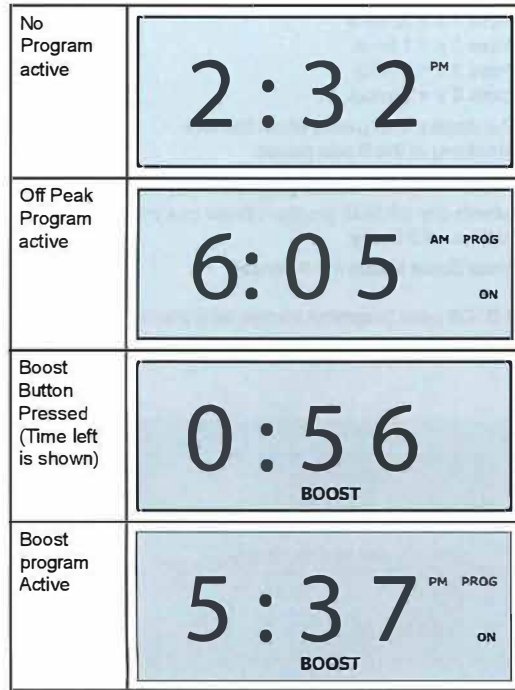

Set/Review

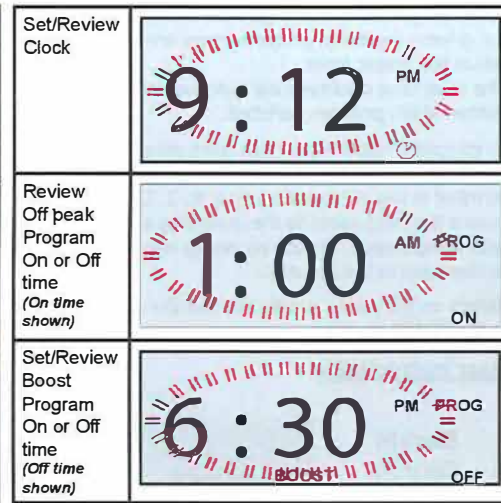

NB: If time is flashing this indicates times may be altered.

**Tariff Table**

Winter							Summer						
	ON	OFF	ON	OFF	ON	OFF	ON	OFF	ON	OFF	ON	OFF	
<b>Economy 7</b>													
0-3	12.30 AM	6.30 AM											
<b>Eco 20:20</b>													
4	9.00 PM	7.00 AM											
<b>Economy 10</b>													
5	12.00 AM	7.00 AM	2.00 PM	5.00 PM	7.00 PM	10.00 PM	12.00 AM	7.00 AM	2.00 PM	5.00 PM	7.00 PM	10.00 PM	
6	2.00 AM	7.00 AM	2.00 PM	4.00 PM	7.00 PM	10.00 PM	2.00 AM	7.00 AM	2.00 PM	4.00 PM	7.00 PM	10.00 PM	
7	12.00 AM	5.00 AM	1.00 PM	4.00 PM	8.00 PM	10.00 PM	12.00 AM	5.00 AM	1.00 PM	4.00 PM	8.00 PM	10.00 PM	
8	4.30 AM	7.30 AM	1.00 PM	4.30 PM	8.30 PM	12.30 AM	4.30 AM	7.30 AM	1.00 PM	4.30 PM	8.30 PM	12.30 AM	
9	12.00 AM	8.00 AM	8.00 AM	4.00 PM	4.00 PM	12.00 AM	12.00 AM	8.00 AM	8.00 AM	4.00 PM	4.00 PM	12.00 AM	

NB: Program times are adjustable within the preset limits.  
 Program 9 offers most flexibility to adjust times to suit individual requirements. However it should be noted that the preset times must be adjusted otherwise the unit will remain permanently ON.

**SERVICE AND WARRANTY**

Your E10 Supremesaver controller is not user serviceable. PLEASE DO NOT TRY TO DISMANTLE THE UNIT. This product is guaranteed by your supplier for 5 years from the Date of Manufacture. If it should become defective, please contact your installer or supplier for a replacement unit.

The Electric Heating Company, Block 5, Unit 40, Third Road,  
 Blantyre Industrial Estate, Blantyre, G72 0UP  
 Tel: 01698 820533 Fax: 01698 825697  
 www.electric-heatingcompany.co.uk

# E10 SUPREME SAVER



The E10 Supreme Saver Dual is a Water Heater Controller that combines ease of use with the efficient control of your hot water tank during cheap rate electricity periods to provide hot water when required.

Should more hot water be required then pressing the 'boost' button will switch on the boost immersion element for ½, 1 or 2 hours to heat up part of the tank.

Where extra hot water will be required every day at the same time, a 'boost' program of up to 2 hours can be entered. Again this will operate the boost immersion element to heat up part of the tank.

Single Immersion Heater

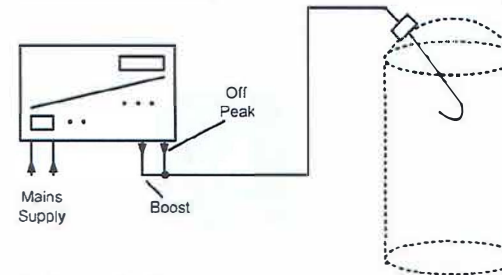

Dual Immersion Heater

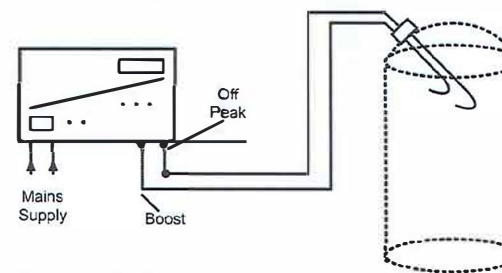

Two Immersion Heater

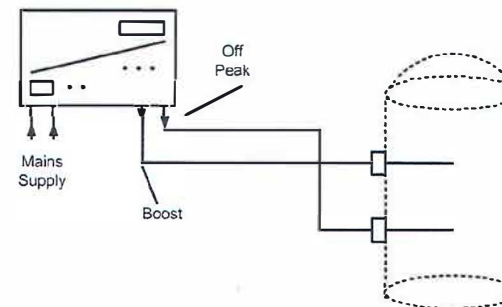

fig 1

Rating	13A, 230V, 50Hz, suitable for immersion heaters up to 3kW
Live Parts	Enclosed
Power Consumption	1.45W
Dirt Protection	IP30
Shock Protection	Class 1
Contacts	Micro-Disconnection
Temperature	0 – 35° C
Battery Reserve	Approx 2 years, Non Rechargeable Lithium
Clock Accuracy	± 5 mins per year @25° C
Dimensions	HxWxD(mm) – 114x169x60
Program Cycle	24hour
Summer/Winter Time change	automatic
Off Peak Program	Installer Selectable - Up to 10 adjustable presets available covering low rate electricity tariffs.
Boost Facility	User selectable – ½, 1 or 2 hours
Boost Program	User Selectable – Up to 2 hours

**Installation Instructions**

The installation should be carried out by a suitably qualified person in accordance with the current edition of the IEE wiring regulations.

**Warning – Isolate mains before starting installation & servicing.**

Provision must be made in the fixed wiring for a means of disconnection from the supply having a contact separation of at least 3mm on all poles. This can be provided by the consumer unit.

The E10 Supreme Saver is supplied with its own mounting box, which can be mounted over a single or double gang flush wall box. This product is not suitable for mounting on unearthed metal or metalised surfaces.

**Mounting**

The E10 Supreme Saver should be removed from the mounting box by unscrewing the 2 captive pattress screws.

Conduit box mounting – Use either holes marked 'C' in fig 2 to secure to a single gang box or the two holes marked 'B' for a double gang box. Cable entry is through the rear break out.